

ledd series

applications

Pedestrian guidance
Demarcation lighting

All products in Holophane's LEDD Series are manufactured with Luxeon Lighting Network Approval.



LEDD Series fittings utilise the award-winning Luxeon high power LEDs from Lumileds, which offer distinct advantages over 5mm LEDs, including superior light output and lumen maintenance, housed in a cast aluminium body with a domed 304 grade stainless steel door. These revolutionary LEDs are available in six colours - warm white, cool white, blue, green, red and amber.

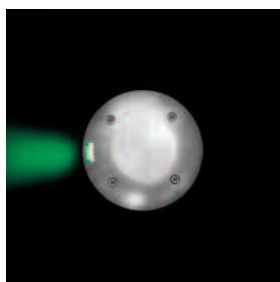

1 way green

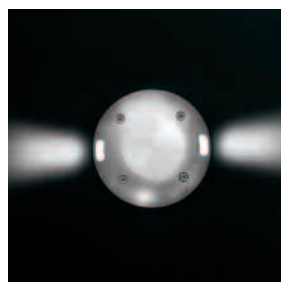

2 way white

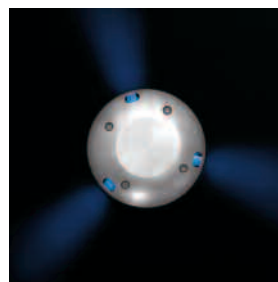

3 way blue

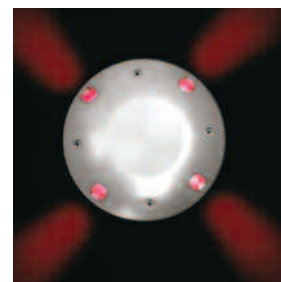

4 way red

features and benefits

Robust construction

- > Durable

Utilising Luxeon high power LEDs from Lumileds

- > Reliable
- > Long life

Higher lumen output than 5mm LEDs

- > Low lens temperature

Suitable for use in public areas

- > IP68

Suitable for wet location areas

lamp types included

marker lights

- 1 x 1.2w Luxeon LEDs
- 2 x 1.2w Luxeon LEDs
- 3 x 1.2w Luxeon LEDs
- 4 x 1.2w Luxeon LEDs
- 6 x 1.2w Luxeon LEDs

IP rating

IP689 

approvals

Complies with EN60598

CE

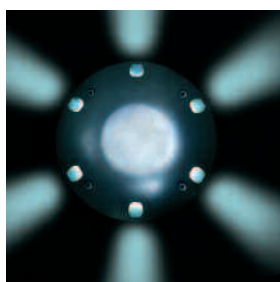

6 way led

LEDD dome top
marker light



specification

LEDD series

The luminaire shall consist of a LM24 marine grade cast aluminium body with a domed 304 grade stainless steel surface bezel. The bezel shall have one, two, three, four or six apertures with an acrylic lens housing one 1.2W Luxeon high power LED per aperture. Available colours of the LEDs shall be warm white, cool white, blue, green, red or amber. The luminaire shall be suitable for recessed ground-mounting with a load resistance of 1800kg, complies to EN60598 and be sealed to IP68.

weights & thermal data

Luminaire Type	Weight (kg)	Min Operating Temperature (°C)	Max Ambient Temperature (°C)
LEDD1, LEDD2, LEDD3	1.8	-20	30
LEDD4, LEDD6	3.6	-20	30

The maximum ambient temperatures stated are for exterior use only. For interior use deduct 10°C from the temperature stated



LEDD1, LEDD2, LEDD3

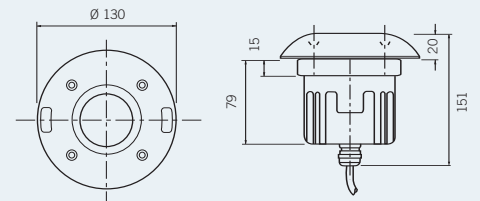

LEDD4, LEDD6

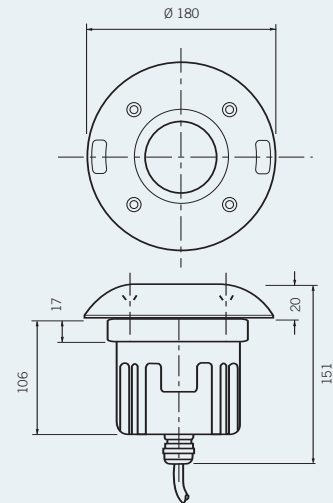

LED.GRS

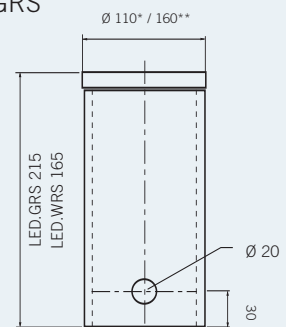

* LED.3GRS / LED.3WRS

** LED6912.GRS / LED6912.WRS

ordering details : luminaire



Code

Code	Dome top LED buried uplighter		
Code	Light Source		
.1WH	1 x 1.2W cool white Luxeon high output LED's (5000K)	1 window aperture	
.1WWH	1 x 1.2W warm white Luxeon high output LED's (3200K)	1 window aperture	
.1BL	1 x 1.2W blue Luxeon high output LED's	1 window aperture	
.1RD	1 x 1.2W red Luxeon high output LED's	1 window aperture	
.1GR	1 x 1.2W green Luxeon high output LED's	1 window aperture	
.1AM	1 x 1.2W amber Luxeon high output LED's	1 window aperture	
.2WH	2 x 1.2W cool white Luxeon high output LED's (5000K)	2 window aperture	
.2WWH	2 x 1.2W warm white Luxeon high output LED's (3200K)	2 window aperture	
.2BL	2 x 1.2W blue Luxeon high output LED's	2 window aperture	
.2RD	2 x 1.2W red Luxeon high output LED's	2 window aperture	
.2GR	2 x 1.2W green Luxeon high output LED's	2 window aperture	
.2AM	2 x 1.2W amber Luxeon high output LED's	2 window aperture	
.3WH	3 x 1.2W cool white Luxeon high output LED's (5000K)	3 window aperture	
.3WWH	3 x 1.2W warm white Luxeon high output LED's (3200K)	3 window aperture	
.3BL	3 x 1.2W blue Luxeon high output LED's	3 window aperture	
.3RD	3 x 1.2W red Luxeon high output LED's	3 window aperture	
.3GR	3 x 1.2W green Luxeon high output LED's	3 window aperture	
.3AM	3 x 1.2W amber Luxeon high output LED's	3 window aperture	
.4WH	4 x 1.2W cool white Luxeon high output LED's (5000K)	4 window aperture	
.4WWH	4 x 1.2W warm white Luxeon high output LED's (3200K)	4 window aperture	
.4BL	4 x 1.2W blue Luxeon high output LED's	4 window aperture	
.4RD	4 x 1.2W red Luxeon high output LED's	4 window aperture	
.4GR	4 x 1.2W green Luxeon high output LED's	4 window aperture	
.4AM	4 x 1.2W amber Luxeon high output LED's	4 window aperture	
.6WH	6 x 1.2W cool white Luxeon high output LED's (5000K)	6 window aperture	
.6WWH	6 x 1.2W warm white Luxeon high output LED's (3200K)	6 window aperture	
.6BL	6 x 1.2W blue Luxeon high output LED's	6 window aperture	
.6RD	6 x 1.2W red Luxeon high output LED's	6 window aperture	
.6GR	6 x 1.2W green Luxeon high output LED's	6 window aperture	
.6AM	6 x 1.2W amber Luxeon high output LED's	6 window aperture	
	Code	Options	
	.TW	Through-wiring option	
Example	LEDD	.3BL	.TW

luminaire accessories

order separately for on site installation by others

Code	Aluminium Ground Recessing Sleeve	Code	Cast Aluminium Wall Recessing Sleeve
LED.3GRS	For 1, 2 or 3 x 1.2W Dome Top In-Grade LED Luminaire*	LED.3WRS	For 1, 2 or 3 x 1.2W Dome Top In-Grade LED Luminaire*
LED.6912GRS	For 4 or 6 x 1.2W Dome Top In-Grade LED Luminaire*	LED.6912WRS	For 4 or 6 x 1.2W Dome Top In-Grade LED Luminaire*
LED.ILC	IP68 Inline Connector		

* Holophane recommend the use of a recessing sleeve accessory for all types of recessed installation. The aluminium sleeve improves heat dissipation from the luminaire into the mounting sub-strata, which improves the operating characteristics of the LEDs.



LED.3GRS - Aluminium Ground Recessing Sleeve



LED.6912GRS - Aluminium Ground Recessing Sleeve



LED.ILC - IP68 Inline Connector



LED.WRS - Cast Aluminium Wall Recessing Sleeve



.TW - Through Wiring Option